

Features

- + High Definition analog HD-TVI or AHD output
- + Resolution up to 1920x1080p @ 30fps
- + Seamless connection to zoom camera blocks with industry standard LVDS interface
- + 1080p25/30 video format support
- + 720p50/60 video format support (HD-TVI only)
- + MCX 75 Ohm right angle coaxial connectors
- + CVBS loop out (to be supported by camera)
- + RS232 and TTL level serial camera control interface
- + RS485 camera control interface (optional)
- + Supply voltage 9V to 12V DC regulated
- + RoHS and UL/UR compliant
- + TLCK-B-0200 Cable Kit included

Applications

- + Full HD integrated cameras with long reach cable requirements
- + Industrial, medical, security, law enforcement

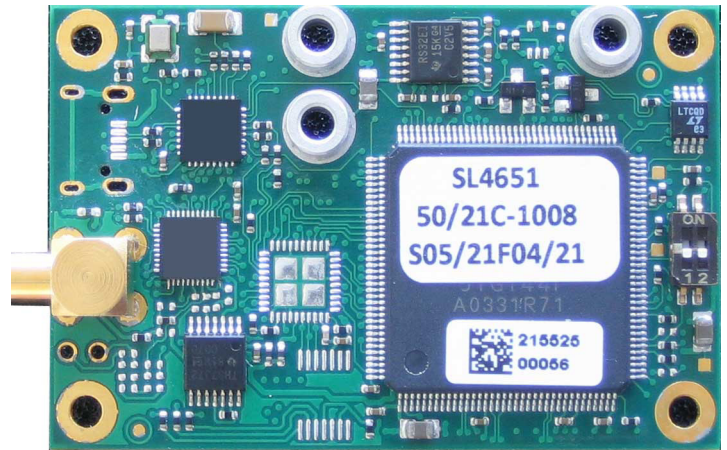

General Description

SL4651 is a small form factor HD-TVI/AHD analog HD video transmitter. Camera LVDS video input signals are demultiplexed, processed and output over a MCX coaxial connector.

Camera control is accomplished by a transparent full duplex communication channel. Physical interface between camera and camera controller / PC is based on RS232, 3.3V TTL or RS485(optional) level. TLCK-B-0200 cable kit is included and contains 30wire micro coaxial cable for connecting SL4651 to the camera as well as 10wire power supply and serial control cable harness.

Coaxial Connector Options

SL4561-D-ST, Straight DIN7A (MOQ)

SL4561-D-RA, Right angle DIN7A (MOQ)

SL4561-M-ST, Straight MCX (MOQ)

SL4561-M-RA, Right angle MCX (standard version)

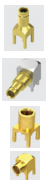

Quick Specification

- Dual LVDS (8CH) interface on 30pin microcoax connector
- Up to 1920x1080@30fps HD-TVI or AHD video output
- Supply voltage 12V DC
- Operating ambient temperature range -10°C to +60°C
- Operating humidity range 20% to 80%
- Power consumption 4.56W with 12V DC supply voltage with Sony FCB-EV7520A camera
- Board size (L x W) 55mm x 36mm
- Wire/cable kit for camera and external interconnect
- RoHS compliant (2002/05/EG and 2011/65/EU)
- UL/UR compliant

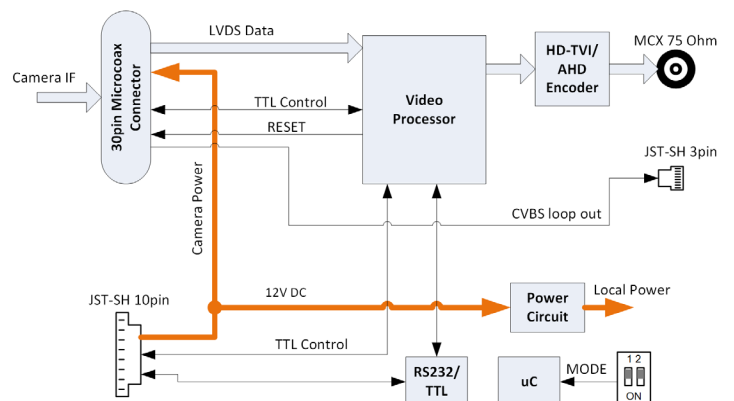

Internet: www.aivion.com
E-Mail: sales@aivion.com

V2.1.x datasheets are valid for revision C boards with onboard video output mode switch and CVBS loop out connector.

Board Mechanical (top view)

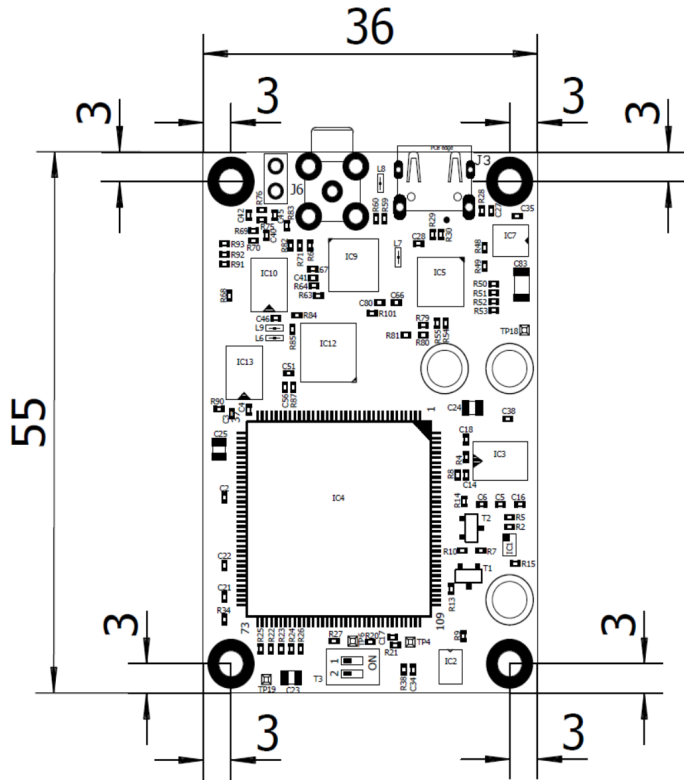

- + Component height top side = 3.0mm (spacer), 6.5mm (J6)
- + Max. component height bottom side = 3.0mm (J1, J4)
- + PCB thickness 1.44mm
- + Mounting holes drill diameter 2,6mm, land diameter 5,0mm

Onboard Mode Switch:

- Switch #1
SL4651 Video Output Mode: OFF=HD-TVI, ON=AHD
- Switch #2
Camera Monitoring Mode Adjust: OFF=No change, ON*=Force 1080p30

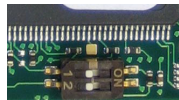

*SL4651 onboard microcontroller adjusts camera video output setting to 1080p30 if switch #2 is in ON position. Checking switch #2 is done once during SL4651 boot cycle. Changing switch #2 position during board operation has no effect. Also switch #1 must be preset before power is applied to SL4651.

Onboard Connectors

- J1: (JST SM10B-SRSS-TB)
- 1 DC Supply voltage input
 - 2 DC Supply voltage input
 - 3 GND (0V)
 - 4 GND (0V)
 - 5 Reset*
 - 6 GND
 - 7 TXD_TTL (serial IF transmit 3.3V, optional)
 - 8 RXD_TTL (serial IF receive 3.3V, optional)
 - 9 RXD_232 (serial IF receive RS232 level)
 - 10 TXD_232 (serial IF transmit RS232 level)

*Pull pin 5 to GND(0V) for 1ms or longer for reset, leave open for normal operation.

- J5: (KEL USL00-30L-A)
- 30wire microcoax connector for camera IF. Use 30wire micro coaxial cable supplied with cable kit.
- J6: HD-TVI/AHD output connector (Samtec MCX7-J-P-H-RA-TH1)
- J8: (JST SM03B-SRSS-TB)
- 1 GND (0V)
 - 2 CVBS loop out from 30pin camera connector**
 - 3 GND (0V)

**CVBS output on 30pin connector must be supported by camera

J2, J3, J4, J7: Not assembled / do not connect.

Power and Environment

POWER INPUT:

9V to 12V DC regulated supply input voltage range

CHARACTERISTICS:

- $P_D = 4.08W$ (MP1110M-VC camera lens steady +SL4651)
- $P_D = 4.56W$ (FCB-EV7520A camera lens steady +SL4651)
- $P_{SL4651} = 1.28W$ (typ.)
- (12V DC supply, 1920x1080@30fps, $T_A = 25^\circ C$, Humidity = 40%)

OPERATING AND STORAGE CONDITIONS:

Ambient temperature (min/max) $-10^\circ C/60^\circ C = 14^\circ F/140^\circ F$

Humidity: 20% - 80%

SL4651 is RoHS compliant (2002/05/EG and 2011/65/EU)

Board Bottom Side

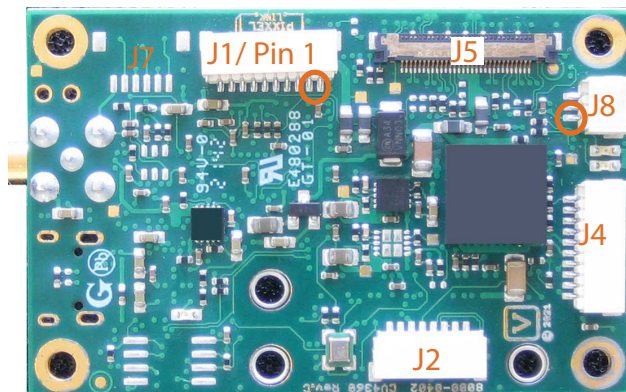

Board Top Side

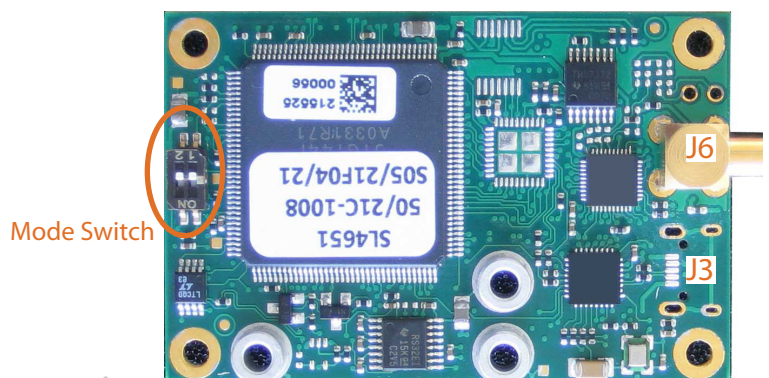

Internet: www.aivion.com
E-Mail: sales@aivion.com

3D CAD model (Step Format) is available on request.

